

CELL lampada da tavolo

Matteo Ugolini design

anno 2011

SCHEMA TECNICA - M612B

CORPO LAMPADA "A"

materiale	filo metallico	
colore	bianco lucido	

DIFFUSORE "B"

materiale	lino	
colore	bianco	

CAVO ELETTRICO "C"

materiale	PVC	
colore	trasparente	

DISPOSITIVO ELETTRICO

portalampane	E27
sorgente luminosa	max 1x52w
classe energetica	da E a A++





PACKAGING

n° colli	1
peso netto/kg	5
peso lordo/kg	6,5
imballo/cm	62x62x65

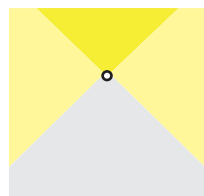
EMISSIONE LUMINOSA

unidirezionale



	diretta
	filtrata
	indiretta
	assenza

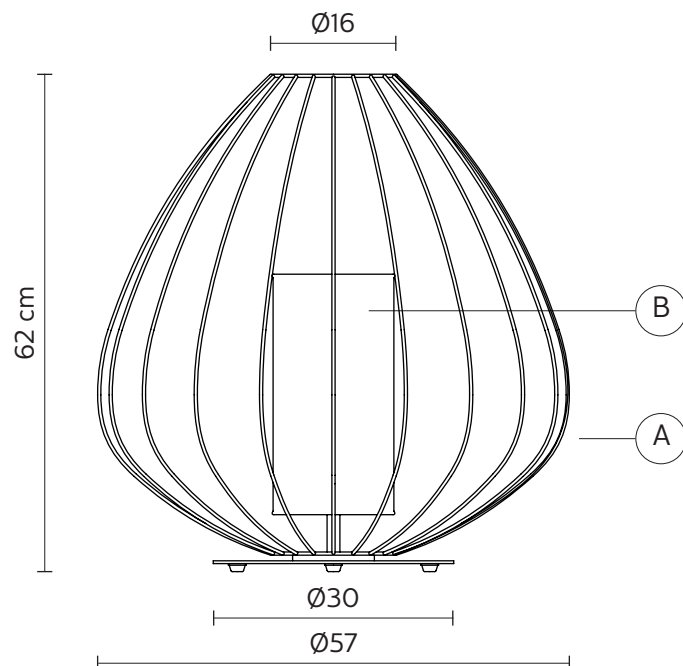

CERTIFICAZIONI

IEC	60598-1:2008
EN	60598-1:2008 + A11:2009



grado di protezione lampadina	IP20 non inclusa
-------------------------------	---------------------

COLLEZIONE

disponibile anche nella versione sospensione (interno e esterno)

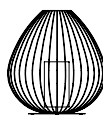

M613B



M614B



M615B



M612-EXT

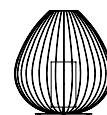

M613-EXT



M615-EXT